



**Verified Carbon
Standard**

DISTRIBUTION OF IMPROVED COOK STOVE - PHASE III



India's Largest Carbon Credit Developer & Supplier

Document Prepared By EKI Energy Services Limited

Contact Information: Office No. 201, EnKing Embassy Plot No. 48, Scheme No. 78
Part II, Vijay Nagar Indore – 452001

Project Title	Distribution of Improved cook stove - Phase III
Version	03
Date of Issue	26-July-2022
Prepared By	Mr. Pankaj Rajpoot
Contact	Manager Operations – GHG Services EKI Energy Services Limited Email ID : pankaj@enkingint.org T +91 731 42 89 086, M +91 7828347589 Address: Office no. 201, Plot 48, Scheme 78 part 2, Vijay Nagar Indore - 452010 (M.P, India) Website www.enkingint.org

CONTENTS

1	PROJECT DETAILS.....	3
1.1	Summary Description of the Project	3
1.2	Sectoral Scope and Project Type	6
1.3	Project Eligibility	6
1.4	Project Design	6
1.5	Project Proponent	7
1.6	Other Entities Involved in the Project	7
1.7	Ownership.....	7
1.8	Project Start Date	8
1.9	Project Crediting Period	8
1.10	Project Scale and Estimated GHG Emission Reductions or Removals	8
1.11	Description of the Project Activity	9
1.12	Project Location	12
1.13	Conditions Prior to Project Initiation	17
1.14	Compliance with Laws, Statutes and Other Regulatory Frameworks	26
1.15	Participation under Other GHG Programs	27
1.16	Other Forms of Credit.....	27
1.17	Additional Information Relevant to the Project	28
2	SAFEGUARDS	29
2.1	No Net Harm	29
2.2	Local Stakeholder Consultation	29
2.3	Environmental Impact	30
2.4	Public Comments	30
2.5	AFOLU-Specific Safeguards	30
3	APPLICATION OF METHODOLOGY.....	30
3.1	Title and Reference of Methodology	30
3.2	Applicability of Methodology	30
3.3	Project Boundary	33
3.4	Baseline Scenario	34
3.5	Additionality	34
3.6	Methodology Deviations	35
4	QUANTIFICATION OF GHG EMISSION REDUCTIONS AND REMOVALS	35
4.1	Baseline Emissions	35
4.2	Project Emissions	35
4.3	Leakage.....	35
4.4	Net GHG Emission Reductions and Removals.....	35
5	MONITORING	37
5.1	Data and Parameters Available at Validation	37
5.2	Data and Parameters Monitored.....	37
5.3	Monitoring Plan.....	37

1 PROJECT DETAILS

1.1 Summary Description of the Project

Purpose of the Project Activity

Purpose of the project activity is to facilitate clean cooking practices and reduce health risk due to indoor air pollution¹ along with household drudgery amongst the tribal households (Schedule Tribe) and families living below the poverty level (BPL category²) in villages of Maharashtra through dissemination of improved cook stoves. The improved cook stoves through replacement of inefficient traditional cook stove will contribute towards reduction of greenhouse gas emission and by-products of incomplete combustion like black carbon, conservation of fuel wood and thereby preventing forest degradation. Successful operation of the project activity will encourage rural residents to shift from traditional cook stoves usage to the project improved and modern cook stove usage.

The higher efficiency portable, single pot cook stoves distributed and conceived under the project activity has replaced prevailing practice of using traditional cook stoves in rural areas across the state. Independent research reveals that, out of 120 million of the total potential of biomass cook stove in India total number of household using cook stoves is around 14.904 million (WHO, UNDP 2009)³ only. Study by ESMAP revealed that, improved cook stoves accounted for less than 7 percent of the total biomass stoves used in rural areas. The report also refers to the latest national survey in India highlighting the fact that, only 5 percent of rural households possess an improved cook stove (Zhang et al. 2006). The study portrays Maharashtra amongst one of those few states where, improved cook stoves were distributed under the National Programme of Improved Chulha (NPIC) since 1983-84 and continued thereafter. The distribution was facilitated through Rural Development and Water Conservation Department, Maharashtra Energy Development Agency and Khadi and Village Industries Commission. Even after prolonged period of distribution since 1983, around 85% of households in the villages of Maharashtra still rely on traditional cook stoves.

¹ Household Cook stoves, Environment, Health and Climate Change – World Bank (Executive summary, page 9-11)

² As per the article in The Hindu dated 20-March-2012 anyone with daily consumption expenditure below Rs. 22.42 is categorised under BPL. The article depicts of 24.5% of the total population in Maharashtra under BPL in 2009-10. The article depicts that Scheduled Tribes (47.4%) suffers the highest level of poverty across the country

³ Household Cook stoves, Environment, Health and Climate Change – The World Bank

It is worthwhile to note that firewood and wood chips contributes as major cooking fuel amongst rural households in India. According to the NSSO 61st round survey, a considerable percentage of rural population of Maharashtra relies upon fire wood for cooking and the percentage is substantially much higher amongst the lower MPCE (Monthly Per Capita Expenditure) group. Since, the beneficiary selected under the project belongs to BPL and ST category of population in terms of capacity of expenditure therefore; improved cook stove use will result in substantial fuel wood saving as this section is the major consumer of fuel wood.

MPCE Groups	Percentage of Population using firewood
Rs. 0 – 235/-	79.2%
Rs. 235 – 270/-	93.8%
Rs. 270 – 320/-	90.0%
Rs. 320 – 365/-	87.2%
Rs. 365 – 410/-	86.2%
Rs. 410 – 455/-	84.2%
Rs. 455 - 510/-	82.8%

The improved cook stoves distributed are more efficient with thermal efficiency of 29.88% as compared to traditional stoves with thermal efficiency of around 10%. Use of efficient cook stove will result in fuel consumption reduction i.e. non-renewable biomass (since the demand of fire wood is considerably higher than the sustainable potential of fire wood extraction and the wood available through unsustainable extraction is conceived as non-renewable biomass) through minimizing thermal energy losses by facilitating complete combustion and thereby resulting in GHG emission reduction.

Technology Employed

The cook stove deployed under the project activity is single pot, portable, metallic, improved biomass cook stoves made of cast iron for combustion of solid biomass. The improved cook stoves are manufactured in accordance to IS 13152, Part-1: 1991, CPRI Design Type I standard. The design ensures complete combustion of biomass. The cook stove is tested for thermal efficiency of 29.88% as per water boiling test protocol specified in IS 13152, Part 1: 1991.

Measures undertaken

The Rural Development and Water Conservation (RDWC) Department, Government of Maharashtra is involved in promoting betterment of living standard for the tribal household (ST) and families living Below Poverty Line (BPL) in villages of Maharashtra. The department as a part of its aforesaid programme selects households from amongst the ST and BPL category depending upon level of vulnerability (assessed on basis of 13 parameters: Category and size of usable land, Type of house, Availability of regular usable clothes, Protection of food or food security, Cleanliness, Ownership of required goods, Heights /Level of literacy, Family working capacity, Source of livelihood goods, Number of children in age group (5 to 14), Type of bankruptcy, reason for staying away from family of Earning member, Choice of help /Yojana) and provide financial assistance to facilitate better and hygienic living standard. The household selected for financial assistance under the programme is provided with an improved cook stove system. The household considered as end users of cook stoves under the project activity are poor enough to afford procurement of cook stoves and are also least interested towards investment as wood is available for free. So, in absence of the cook stove the household would have continued with traditional cooking practice. Since, the project activity is conceived under the program of Govt. of Maharashtra which provides cook stove only to BPL and ST category household so; there is no chance of cook stove to be distributed to non-baseline household. The identification of beneficiaries and distribution of cook stoves comes under the preview of the Rural Development and Water Conservation Department.

The project activity plans to disseminate improved cook stoves over period of time amongst Below Poverty Line (BPL) and Scheduled Tribes (ST) households in rural areas of Ahmednagar and Nandurbar districts of Nashik Division in Maharashtra. The project is to consider beneficiaries comprising of 14,600 Nos. of household to whom improved cook stoves are to be disseminated under the programme and has signed the end user Tripartite Agreement. The project through conservation of non-renewable biomass will result in greenhouse gas emission reduction of 13,125 tCO_{2e} annually.

Vikram Stoves and Fabricators (hereafter referred to as Vikram Stoves) is a MNRE (Ministry of New and Renewable Energy) approved manufacturer and distributor of improved cook stoves having operation network in Maharashtra. The agency is selected by the RDWC Department, Government of Maharashtra for distribution of improved cook stoves amongst identified beneficiaries. With an objective of wide spread dissemination (under limited annual budgetary support provision of the Ministry) of improved cook stoves and facilitate continual usage at beneficiary level; the manufacturer conceived CDM in its revenue model. The revenue was conceived in deciding upon the capital cost as well as to meet up the cost

towards imparting awareness and training, periodic maintenance and post lifetime replacement within the crediting period.

In the baseline scenario, the absence of the project would have led to underneath options for the purpose of cooking

1. Continuation of use of traditional stoves for the purpose of cooking
2. Use of kerosene for cooking
3. Use of LPG for Cooking
4. Use of biomass based improved cook stove

Use of the traditional cook stove is the most plausible baseline option for the target population.

Kindly refer section 1.13 for further details

M/s G K Energy Marketers Pvt Ltd (hereafter referred to as GKEMPL) is authorised as Project Participant by Vikram Stoves and the end users for development of CDM project activity for cook stove dissemination. As a part of the project activity GKEMPL (Project Participant) along with Vikram Stoves will enter into contractual agreement with the beneficiaries by virtue of which, the end user will confirm use of cook stove as well as transfer the CER right to the Project Participant.

1.2 Sectoral Scope and Project Type

The project activity falls under Sectoral Scope 3: Energy Demand

This project is not grouped project because there is no addition other project activity.

This is non-AFLOU type of project.

1.3 Project Eligibility

The project activity involves replacement of the traditional cook stoves by improved cook stoves. The improved cook stoves owing to its higher combustion efficiency of 29.88% in comparison to 10% efficiency of the traditional cook stoves results in efficiency improvement and same do not exceed equivalent of 20 Giga watt hour (GWh) (60 giga watt hour thermal (GWhth))per year. Hence the project activity is eligible Sectoral scope 3 i.e. energy demand under the scope of the VCS Program.

1.4 Project Design

The project activity plans to disseminate the improved cook stoves over period of time amongst BPL (Below Poverty Line) and Scheduled Tribes (ST) households in rural areas of Solapur district of Pune division in Maharashtra. The project consider beneficiaries comprising of 14,600 Nos. of household to whom improved cook stoves are disseminated under the project activity and have signed the end user Tripartite Agreement

Eligibility Criteria

Not applicable to this project activity as this is not a grouped project.

1.5 Project Proponent

Organization name	M/s G K Energy Marketers Pvt. Ltd
Contact person	Mr. Gopal Kabra
Title	Authorized Signatory
Address	Lokmanya Nagar, LBS Road, Flat No.- 350, Building No.- 25,Ground Floor, Pune, Maharashtra – 411030 India
Telephone	+91 99704 50000
Email	gopal@energymarketers.in

1.6 Other Entities Involved in the Project

Organization name	EKI Energy Services Limited
Role in the project	Project Consultant
Contact person	Mr. Pankaj Rajpoot
Title	Manager- Operations
Address	Office No 201, Plot No 48, Scheme 78, Vijay Nagar Part- II, Indore 452010, India
Telephone	+91- 7828347589
Email	pankaj@enkingint.org

1.7 Ownership

As per VCS Program Definitions version 4, the project ownership is the legal right to control and operate the project activities.

As per CDM Project Design Document section A.2, M/s. G K Energy Marketers Pvt Ltd (hereafter referred to as GKEMPL) is authorized as Project Participant by Vikram Stoves and the end users for development of VCS project activity for securing carbon financing for the cook stove disseminated . As a part of the project activity GKEMPL (Project Participant) along with Vikram Stoves has entered into contractual agreement with each beneficiaries

by virtue of which the end user will confirm use of cook stove as well as transfer the CER right to the Project Participant

Based on above evidences, the project ownership is demonstrated and M/s. G K Energy Marketers Pvt Ltd is authorized project owner.

1.8 Project Start Date

The start date of the project activity is 20-November-2012.

The project activity relating to improved cook stove usage by the end user does not require any construction or significant pre-project implementation, nor financial commitment on the part of end user. The real action pertaining to the earliest date of handover of improved cook stoves to beneficiary (also considered as date of onset of GHG emission reductions) under the project activity is considered as the start date as per project start date definition under paragraph 3.7 of the VCS Standard.

The distribution was initiated once all the Improved cookstoves (disseminated under the project activity) were supplied to the office of the concerned line department by the manufacturer and the project proponent has completed signing of tripartite agreement with selected beneficiaries.

The date of supply/ receipt of first lot of improved cookstoves from manufacturer to the regional office of the line department was considered as start date under the CDM registered PDD (evidenced through acknowledgement of the delivery receipt of the line department) as per CDM definition of Start Date. Since the date does not resembles to handover of the cookstoves to beneficiary and does not result in onset of actual emission reduction therefore the same cannot be considered as start date under VCS mechanism and therefore the date of distribution/ handover of improved cookstoves to beneficiary is considered as the start date.

1.9 Project Crediting Period

The crediting period of the project activity is for 10 years (Fixed).

The length of the first crediting period is 20-November-2012 to 19-November-2022 (both dates inclusive).

As per errata and clarification, a project is deemed to have met the timelines where Verra confirmed (in writing, to the project proponent or an authorized representative) the project's eligibility on or before 4-February-2021. The listing process has been completed before 04-February-2021 and hence the errata and clarifications are not applicable

1.10 Project Scale and Estimated GHG Emission Reductions or Removals

The project activity falls under small-scale project category since the annual average GHG emission reductions are less than 300,000 tCO₂e

Project Scale	
Project	√
Large project	

Year	Estimated GHG emission reductions or removals (tCO _{2e})
20-November-2012 to 19-November-2013	13,125
20-November-2013 to 19-November-2014	13,125
20-November-2014 to 19-November-2015	13,125
20-November-2015 to 19-November-2016	13,125
20-November-2016 to 19-November-2017	13,125
20-November-2017 to 19-November-2018	13,125
20-November-2018 to 19-November-2019	13,125
20-November-2019 to 19-November-2020	13,125
20-November-2020 to 19-November-2021	13,125
20-November-2021 to 19-November-2022	13,125
Total estimated ERs	131,250
Total number of crediting years	10
Average annual ERs	13,125

1.11 Description of the Project Activity

The improved cook stove conceived under the project activity is MNRE and BIS (Bureau of Indian Standard) approved state of art and environmentally sound technology. The improved cook stove is manufactured in accordance to IS13152 (Part 1): 1991(Solid Biomass – Chulha Part 1(Metallic)). This Indian Standard was adopted by the Bureau of Indian Standard after the draft specification was finalized by the oil burning Appliances Sectional Committee had been approved by Heavy Mechanical Engineering Division Council. There has been no transfer of technology for the project activity. The standard has been prepared in line with the national approach towards fuel conservation, better environment, mitigating health hazards and loss of forest cover caused by burning of wood as cooking fuel and therefore can be conceived as an environmentally sound technology for combustion of solid biomass for the purpose of cooking. Moreover the materials used in the manufacturing of the cook stove are of iron and steel which is recyclable after end use and hence considered to be environmentally safe after lifetime also.

The cook stove distributed under the project activity is a portable, single-pot stove without chimney, natural draft and metal made stove specifically suitable for combustion of solid biomass. The cook stove broadly comprises of a combustion chamber, top plate for holding the utensils, grate for holding fuel during combustion and bottom plate that facilitates ventilation of air. The combustion chamber is cylindrical shaped and made up of mild steel. One side of the chamber of improved cook stove is opened for feeding of fuel. The chamber top plate is die cast and made up of cast iron.

Diagram of Improved Cook stove

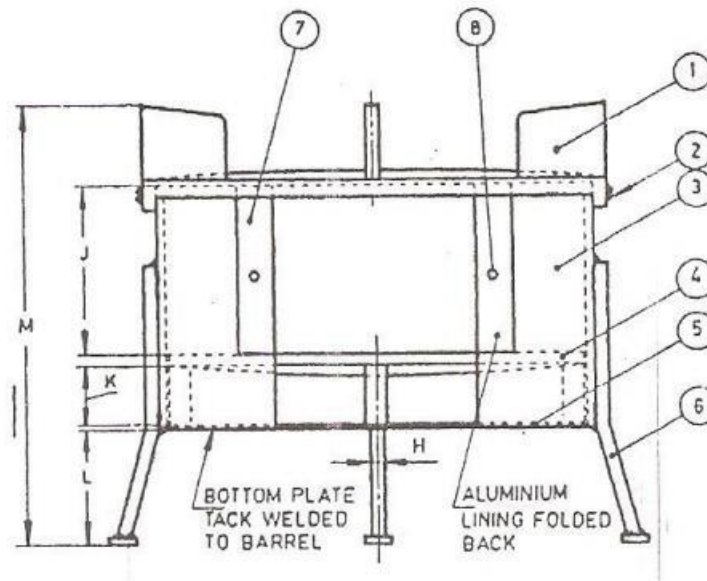

1. Top plate,
2. Screw,
3. Barrel,
4. Grate,
5. Bottom Plate,
6. Legs,
7. Aluminum Lining and
8. Rivet

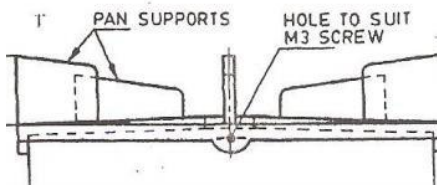
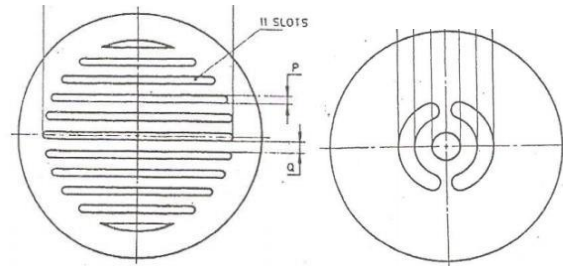

Figure 1.a. Top Plate Figure



1.b. Grate Figure 1.c. Bottom Plate

Improved Cook stove



Material used for manufacturing of each component of the cook stoves are:

Component	Material
Top plate	Cast iron
Grate	Cast iron
Barrel	Mild steel
Bottom Plate	Mild steel
Lining	Aluminium
Perforated Sleeve	Mild steel
Handle	Mild steel
Pan Support	Mild steel sheet-flat-rod

Legs	Mild steel sheet and rod
------	--------------------------

1.12 Project Location

The project is located in state Maharashtra, India.

The list of division is given below:

Division: Nashik

Districts: Ahmednagar and Nandurbar

District	Ahmednagar	Nandurbar
Latitude	18.20°N to 19.90°N	21.00°N to 22.03°N
Longitude	73.90°E to 75.50°E	73.31°E to 74.32°E

Map of India



Map of Maharashtra

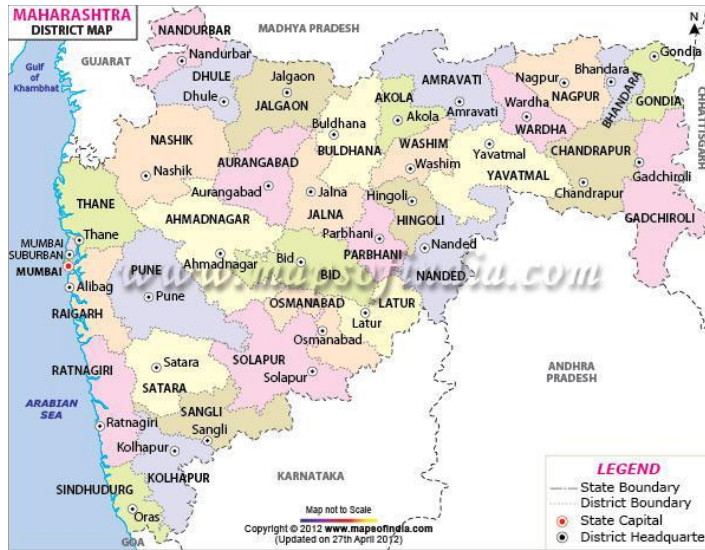

Map of Ahmednagar

Map of Nandurbar

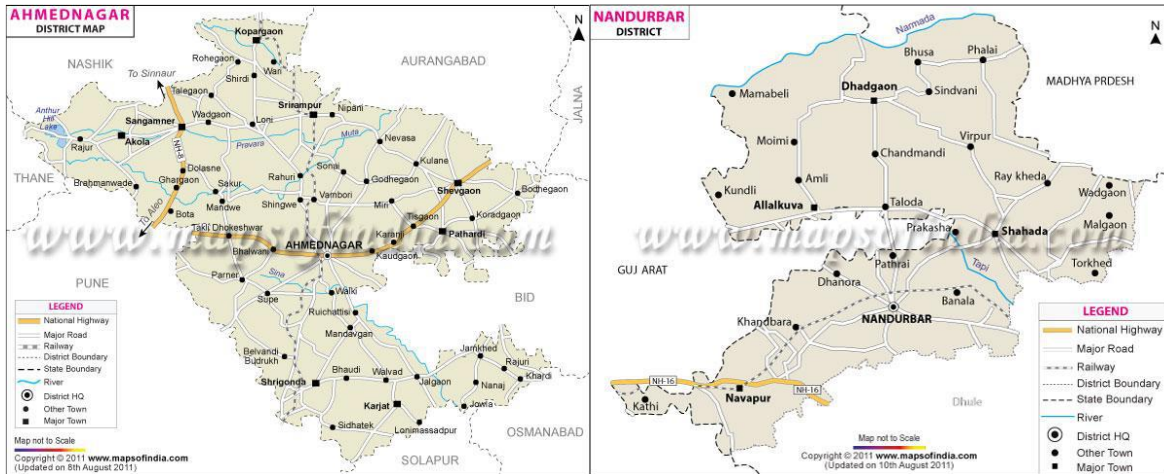

District wise list of Village included in the table below:

District	Ahmednagar
Taluka	Shrirampur

Sr.	Name of the village	Taluka
1	Ainatpur	Shrirampur
2	Belapur Bk.	Shrirampur
3	Belapur Kh.	Shrirampur
4	Bhairavnathnagar	Shrirampur
5	Bhamathan	Shrirampur
6	Bherdapur	Shrirampur
7	Bhokar	Shrirampur

Sr.	Name of the village	Taluka
8	Bramhangaon Vetal	Shrirampur
9	Dattanagar	Shrirampur
10	Dighi	Shrirampur
11	Ekalahare	Shrirampur
12	Fatyabad	Shrirampur
13	Galnimb	Shrirampur
14	Ghumandeo	Shrirampur
15	Gondegaon	Shrirampur
16	Govardhanpur	Shrirampur
17	Gurjarwadi	Shrirampur
18	Haregaon	Shrirampur
19	Jafrabad	Shrirampur
20	Kadit Bk.	Shrirampur
21	Kadit Kh.	Shrirampur
22	Kamalpur	Shrirampur
23	Kanhegaon	Shrirampur
24	Karegaon	Shrirampur
25	Khanapur	Shrirampur
26	Khandala	Shrirampur
27	Khirdi	Shrirampur
28	Khokar	Shrirampur
29	Kuranpur	Shrirampur
30	Ladgaon	Shrirampur
31	Mahankal Wadgaon	Shrirampur
32	Malewadi	Shrirampur
33	Malunje Bk.	Shrirampur
34	Malwadgaon	Shrirampur
35	Mandve	Shrirampur
36	Matapur	Shrirampur
37	Matulthan	Shrirampur
38	Muthewadgaon	Shrirampur
39	Narsari	Shrirampur
40	Naur	Shrirampur
41	Naygaon	Shrirampur
42	Nimgaon Khairi	Shrirampur
43	Nipani Wadgaon	Shrirampur
44	Padhegaon	Shrirampur
45	Rampur	Shrirampur

Sr.	Name of the village	Taluka
46	Sarala	Shrirampur
47	Shirasgaon	Shrirampur
48	Takalibhan	Shrirampur
49	Ukkalgaon	Shrirampur
50	Umbargaon	Shrirampur
51	Undirgaon	Shrirampur
52	Wadala Mahadeo	Shrirampur

District	Nandurbar
Taluka	Shahade

Sr.	Name of the village	Taluka
1	Abhanpur	Shahade
2	Adgaon	Shahade
3	Akaspur	Shahade
4	Alkhed	Shahade
5	Ambapur	Shahade
6	Amode	Shahade
7	Anakwade	Shahade
8	Anarad	Shahade
9	Asalod	Shahade
10	Asus	Shahade
11	Aurangpur	Shahade
12	Awage	Shahade
13	Bahirpur	Shahade
14	Bamkheda-t-sarangkheda	Shahade
15	Bamkheda-t-tarhad	Shahade
16	Bhade	Shahade
17	Bhadgaon	Shahade
18	Bhagapur	Shahade
19	Bhongra	Shahade
20	Bhortek	Shahade
21	Bhulane	Shahade
22	Bhute	Shahade
23	Biladi-t-haveli	Shahade
24	Biladi-t-sarangkheda	Shahade
25	Borale	Shahade

26	Bramhanpuri	Shahade
27	Budigavhan	Shahade
28	Bupkari	Shahade
29	Chandsaili	Shahade
30	Chandsaili	Shahade
31	Chikhali Bk	Shahade
32	Chikhali Kh.	Shahade
33	Chirde	Shahade
34	Chirkhan	Shahade
35	Damalde	Shahade
36	Damerkheda	Shahade
37	Dara	Shahade
38	Deur	Shahade
39	Dhandre Bk	Shahade
40	Dhandre Kh.	Shahade
41	Dhurkheda	Shahade
42	Dondwade	Shahade
43	Dongargaon	Shahade
44	Dudhkheda	Shahade
45	Fattepur	Shahade
46	Fes	Shahade
47	Ganor	Shahade
48	Godipur	Shahade
49	Gogapur	Shahade
50	Hingani	Shahade
51	Hol	Shahade
52	Hol-gujari	Shahade
53	Isalampur	Shahade
54	Jaavade-t-haveli	Shahade
55	Jainagar	Shahade
56	Jam	Shahade
57	Javade-t-borad	Shahade
58	Javkhede	Shahade
59	Junavane	Shahade
60	Kahatul	Shahade
61	Kakarde Bk	Shahade
62	Kakarde Kh	Shahade
63	Kalambu	Shahade
64	Kalmad-t-haveli	Shahade

65	Kalmadi-t-borad	Shahade
66	Kalsadi	Shahade
67	Kamaravad	Shahade
68	Kanadi Kh	Shahade
69	Kanadi-t-haveli	Shahade
70	Kansai	Shahade
71	Karajai	Shahade
72	Karankheda	Shahade
73	Karjot	Shahade
74	Katharde Kh	Shahade
75	Katharde-digar	Shahade
76	Kauthal-t-sarangkheda	Shahade
77	Kauthal-t-shahade	Shahade
78	Kavalith	Shahade
79	Khairve	Shahade
80	Khamkheda	Shahade
81	Khaparkheda	Shahade
82	Khargaon	Shahade

1.13 Conditions Prior to Project Initiation

In accordance to the Paragraph 4 of the chosen methodology, AMS - II.G; “Energy Efficiency measures in thermal applications of non-renewable biomass”, EB 60, Version 03: baseline of the project activity is “the use of fossil fuels for meeting similar thermal energy needs”. In absence of the project activity the beneficiaries could have opted for the underneath options for the purpose of cooking

1. Continuation of use of traditional stoves for the purpose of cooking
2. Use of kerosene for cooking
3. Use of LPG for Cooking
4. Use of biomass based improved cook stove

Use of all the above options for purpose of cooking is permitted as per the regulation of the host country. However, use of few of the fuel options stated above faces barriers as their use in the rural areas are concerned and are depicted below.

As per the study by “National Institute of Science, Technology & Development Studies (NISTADS), CSIR, New Delhi” it is highlighted that poor rural household could not afford and also not willing to opt for the improved cook stoves since wood are available for free.

The household that opts for the improved stoves only opts for subsidy hence the use of biomass based cook stoves is not a pertinent or plausible scenario. The percentages of population relying on different fuel type in rural areas of Maharashtra for the purpose of cooking are as follows⁴ –

	Firewood	LPG	Kerosene	No cooking arrangement	Others
Percentage of population	78%	15%	1%	3%	2%

From above figures it is quite evident that, the percentages of population depending on firewood in the rural areas are quite high in the state. Publication titled “Household Energy and the Environment”⁵ depicts that, although nationally there has been a decrease in the share of traditional fuels, as biomass is being increasingly substituted by commercial fuels, the shift to commercial fuels has been negligible in rural areas. The energy consumption in rural areas is guided by the availability and accessibility of local biomass resources; the competing uses for biomass; availability of commercial energy sources; the cost of commercial fuels such as LPG and kerosene (NCAER 1985); absence of an effective supply especially in the rural areas (TERI 1998); and inadequate production and refining capacity of LPG (Ravindranath and Ramakrishna 1997). Over and above the above barriers the issues of affordability of commercial fuel is quite a bigger issue amongst the populations conceived under the project activity and hence the use of commercial fuel is not usual scenario amongst the BPL and ST population. Therefore, use of LPG or Kerosene is not the plausible baseline option.

From above it can be concluded that the use of biomass in the traditional cook stove is the most plausible baseline option for the target population.

The methodology identifies the baseline and suggests for baseline emission factor therefore, the same is considered as precedence and assessment of alternatives is not carried out for the purpose of determination of baseline and emission factor. According to Paragraph 5 of the applicable methodology, default emission factor of 81.6 tCO₂e/TJ is considered for estimation of emission reduction. Emission reductions would be calculated as:

$$ER_y = B_{y,savings} \times f_{NRB,y} \times NCV_{biomass} \times EF_{projectedfossilfuel}$$

Where:

ER _y	Emission reductions during the year y in tCO ₂ e
B _{y,savings}	Quantity of woody biomass that is saved in tonnes

⁴ TERI Energy Data Directory & Yearbook 2010

⁵ Preeti Malhotra, http://www.hedon.info/BP42_EnvironmentallImplicationsOfTheEnergyLadderInRuralIndia

$f_{NRB,y}$	Fraction of woody biomass saved by the project activity in year y that can be established as non-renewable biomass
$NCV_{biomass}$	Net calorific value of the non-renewable woody biomass that is substituted (IPCC default for wood fuel, 0.015 TJ/tonne)
$EF_{projectedfossilfuel}$	I Emission factor for the substitution of non-renewable woody biomass by similar consumers. Use a value of 81.6 tCO ₂ /TJ ³

$$B_{y,savings} = B_{old} * (1 - \eta_{old}/\eta_{new})$$

Where,

$B_{y,savings}$	Quantity of woody biomass that is saved in tonnes
B_{old}	Quantity of woody biomass used in the absence of the project activity in tonnes
η_{old}	A default value of 0.10 may be optionally used if the replaced system is a three stone fire, or a conventional system with no improved combustion air supply or flue gas ventilation system, i.e. without a grate or a chimney.
η_{new}	Efficiency of the system being deployed as part of the project activity (fraction), as determined using the Water Boiling Test (WBT) protocol.

Determination of Bold:

According to Paragraph 7 of the chosen methodology; Bold is determined by using the Option (a) “Calculated as the product of the number of systems multiplied by the estimated average annual consumption of woody biomass per appliance (tonnes/year). This can be derived from historical data or a survey of local usage.”

According to the Wood Fuel Trade in India – Food and Agricultural Organisation of the United Nation, July 2001; per capita per day biomass consumption is 1.52 kg and per household per day fuel wood consumption is 5.60 kg. Annual consumption per household per day is therefore estimated at 2.044 tonnes.

Further, following the TERI Energy Data Directory and Yearbook 2010; per capita per month consumption of fire wood in Maharashtra is 25.51 kg⁶. With average population size of 4.8 person/ household⁷ (the population size of 4.8 persons per household is obtained from the secondary literature publication that indicates the average number of personnel

⁶ Ref: TERI Energy Data Directory and Year book 2010

⁷ Ref: Pg.No. -3 of A Report on "Morbidity & Health Care Based on Data Collected in Central, State & Pooled Samples of 60th Round of National Sample Survey Jan - Jun2004"

per household in rural areas of Maharashtra as 4.8); annual consumption of firewood is estimated at 1.469 tonnes.

Being the annual household fuel consumption data estimated on the basis of the TERI Energy Data Directory is most conservative the value of 1.469 tonnes/household/year is considered. Therefore,

$$B_{old} = 1.469 \text{ tonnes/ household/ year.}$$

Determination of η_{old}

Since, the project is replacing traditional cooking⁸ system with no improved combustion air supply or flue gas ventilation system therefore, efficiency of the system being replaced is chosen as per Alternative 2 of Option 2 of Paragraph 6 as default value of 0.10.

Determination of η_{new}

Efficiency of the system being deployed in the project activity is chosen as 29.88%⁹ following the Performance Test of Improved Cook stove done by Department of Renewable Energy Sources, Maharana Pratap University of Agriculture & Technology.

$$\eta_{new} = 29.88\%$$

$f_{NRB,y}$ is determined as follows:

According to Paragraph 8 of the chosen methodology, "Project participants shall determine the shares of renewable and non-renewable woody biomass in Bold (the quantity of woody biomass used in the absence of the project activity) the total biomass consumption using nationally approved methods (e.g., surveys or government data if available) and then determine $f_{NRB,y}$ ".

The fraction of woody biomass saved due to the project activity that can be established as non-renewable is estimated as –

$$f_{NRB,y} = NRB / (NRB + DRB)$$

Where,

NRB: Non Renewable Biomass (NRB) is the quantity of woody biomass used in the absence of the project activity (Bold) minus the DRB component.

According to the Paragraph 9 of the applicable methodology; Demonstrably Renewable woody Biomass (DRB) is justified by satisfying the condition no. (1) in following manner –

⁸ Traditional cookstove is being used among all households prior to the project activity as per the baseline survey.

⁹ Thermal Efficiency Test Report of Improved Cook stove tested at Biomass Cook stove Testing Centre, Dept. of Renewable Energy Sources, Udaipur

The wood extracted from forest land in a sustainable quantity is considered as renewable. The wood extracted from forest land in a sustainable quantity is considered as renewable. Further, to demonstrate the woody biomass is renewable the following conditions as per paragraph 9, are satisfied.

1. Land Area Remain a Forest: The forest area (also termed as recorded forest area and represents the total area of land as per the Government records) in Maharashtra across the last five years is as follows –

Study Period	Total area under forest (sq.km)	Reporting Year (Economic Survey Report)
2010-11	61,939	2011-12
2009-10	61,939	2010-11
2008-09	61,939	2009-10
2007-08	61,939	2008-09
2006-07	61,939	2007-08

The table above represents the total area of land under forest in Maharashtra and confirms that, the land under forest continued to remain under forest.

Therefore, it is evident from above information that, the land area under forest continued to remain under forest.

2. Sustainable management practices are undertaken on these land areas to ensure, in particular, that the level of carbon stocks on these land areas does not systematically decrease over time (carbon stocks may temporarily decrease due to harvesting). Sustainable management practices like afforestation, reforestation, preservation and conservation of forest land is undertaken in the country as a part of the National Forest Policy, 1988 by Ministry of Environment & Forests, Govt. Of India. The National Mission for Green India is one of the eight Missions of National Action Plan on Climate Change; that calls for forest conservation policy as policy decision to be implemented by the state government.

In order to prevent illicit cutting of trees and following the request of the government of India, the Maharashtra State had taken an important and pioneering decision regarding forest management with the active participation of the rural people¹⁰. The Joint Forest Management/Forest Protection Committee has selected forest land including degraded and barren forest land and similar other land in rural areas for sustainable management.

3. Any national or regional forestry and nature conservation regulations are complied with. According to the Circular No. FLD/1000/CR 243/F-3 of Government of Maharashtra, the forest land under the state of Maharashtra is abided by Forest Conservation Act 1980. The Forest (Conservation) Act, 1980 and amended in 1988¹¹

¹⁰ <http://www.iifm.ac.in/databank/jfm/mahfdres.html>

¹¹ <http://www.moef.nic.in/legis/forest/forest2.html>

was enacted with a view to check further deforestation which ultimately results in ecological imbalance; and therefore, the provisions made therein for the conservation of Forests and for matters connected therewith, must apply to all forests irrespective of the nature of ownership or classification thereof. This definition of forest covers all statutorily recognized forests, whether designated as reserved, protected or otherwise for the purpose of section 2 (i) of the Forest (Conservation) Act. The Forest Conservation Act vide paragraph 2 also impose restriction on the de-reservation of forests or use of forest land for non-forest purpose.

Since, the woody biomass originating from land area under forest fulfils the specified conditions the same is considered to be renewable.

Fuel Wood Demand

The demand of fuel wood in context of Maharashtra is estimated from percentage share of the rural population relying on fire wood and average per-capita fuel wood consumption. The demand of fire wood in the state is estimated as follows:

Particulars	Data	Unit	Reference
Rural Population	55,778,000.00	Nos.	Economic Survey of Maharashtra 2010-11 (Pg.No.-3)
Percentage of households reliant on biomass for cooking	78.00	%	Teri Energy Data Directory & Yearbook 2010(Pg. No. 294) Although study by NSSO depicts higher percentage of dependency of the rural population in lower strata of MCPE group the conservative figure is used for the purpose of calculation
Population Dependent on the Fuel Wood	43,506,840.00	Nos.	Calculated
Per capita fuel wood consumption for cooking	25.51	kg/ month	Teri Energy Data Directory & Yearbook 2010(Pg. No.-293)
Fuel Wood requirement	13,318,313.86	tonne /year	Calculated

Supply of Fire Wood

Forest is the major source of fire wood supply followed by Tree outside Forest. The amount of fire wood that can be sustainably extracted from the forest and Tree outside Forest land is estimated from the area under different forest type and sustainable rate of extraction from forest and plantation. The same method is applied for estimation of sustainable extraction potential from Tree outside Forest.

As a conservative approach, the land under open forest and scrub are also included.

Sustainable Fuel wood Extraction From Forest Area
--

Particulars	Data	Unit	Reference	Remarks
Very Dense Forest	8,736	sq. km.	Pg. No. -173, Ch -9.16. of India State of Forest Report 2011 -FSI	Land with forest cover having canopy density above 70%
Medium Dense Forest	20,815	sq. km.	Pg. No. -173, Ch -9.16. of India State of Forest Report 2011 -FSI	All Lands with forest cover having a canopy density of 40%- 70%
Open Forest	21,095	sq. km.	Pg. No. -173, Ch -9.16. of India State of Forest Report 2011 -FSI	Land with forest cover having density between 10-40%
Scrub	4,157	sq. km.	Pg. No. -173, Ch -9.16. of India State of Forest Report 2011 -FSI	Degraded forest land with canopy cover less than 10%
Total area under forest	54,803	sq. km.		Calculated
Forest Cover In Different Forest Type				
Tropical dry deciduous forest	57.40%		Pg. No. -174, Ch -9.16. of India State of Forest Report 2011 –FSI	FSI Report Title: India State of Forest Report 2011 By: Forest Survey of India Link: www.fsi.nic.in Report No: 12th Data Period: October 2008 - March 2009
Tropical moist deciduous forest	29.85%		Pg. No. -174, Ch -9.16. of India State of Forest Report 2011 –FSI	
Tropical semi evergreen	7.72%		Pg. No. -174, Ch -9.16. of India State of Forest Report 2011 –FSI	
Tropical thorn forest	1.02%		Pg. No. -174, Ch -9.16. of India State of Forest Report 2011 –FSI	
Sub-tropical broad leaved hill forest	1.54%		Pg. No. -174, Ch -9.16. of India State of Forest Report 2011 –FSI	
Littoral and Swamp	0.09%		Pg. No. -174, Ch -9.16. of India State of Forest Report 2011 –FSI	
Tropical dry deciduous forest		31,457	sq. km.	Calculated
Tropical moist deciduous forest		16,359	sq. km.	Calculated
Tropical semi evergreen		4,231	sq. km.	Calculated
Tropical thorn forest		559	sq. km.	Calculated
Sub-tropical broad leaved hill forest		844	sq. km.	Calculated
Littoral and Swamp		49	sq. km.	Calculated
Sustainable Rate Of Extraction From Forests And Plantation				
Tropical dry deciduous forest	0.22	tonne /ha/yr	Pg. No. 254 of Forestry for sustainable biomass production and carbon sequestration in India- N. H. Ravindranath (Centre for Ecological Sciences, IISc, Bangalore), P. Sudha (Centre for Ecological Sciences, IISc, Bangalore), Sandhya Rao (Dept. of Civil Engineering IIT Delhi)	
Tropical moist deciduous forest	0.27	tonne/ha/yr		
Tropical semi evergreen	0.39	tonne /ha/yr		
Tropical thorn forest	0.24	tonne/ha/yr		
Sub-tropical broad leaved hill forest	0.36	tonne /ha/yr		
Littoral and Swamp	0.36	tonne /ha/yr		
Renewable Biomass Extraction From Forest Area				

Tropical dry deciduous forest	692,052	tonne /year	Calculated
Tropical moist deciduous forest	441,684	tonne /year	Calculated
Tropical semi evergreen	165,000	tonne /year	Calculated
Tropical thorn forest	13,415	tonne /year	Calculated
Sub-tropical broad leaved hill forest	30,382	tonne /year	Calculated
Littoral and Swamp	1,775	tonne /year	Calculated
Total Renewable Biomass Extraction from Forest	1,344,308	tonne /year	Calculated
Sustainable Extraction from Plantation and ToF			
Plantation /Tree Outside Forest	1,304	sq. km	India State of Forest Report 2011 - FSI (Calculated considering the area under Plantation/ToF as 2.38%)
Sustainable Extraction rate from plantation	2.00	tonne /ha/yr	Pg. No. 254 of Forestry for sustainable biomass production and carbon sequestration in India - N. H. Ravindranath (Centre for Ecological Sciences, IISc, Bangalore), P. Sudha (Centre for Ecological Sciences, IISc, Bangalore), Sandhya Rao (Dept. of Civil Engineering IIT Delhi)

Estimation of f_{NRB}

Total Renewable Biomass Extraction from Plantation/ ToF	260,862.28	tonne /year
Total Sustainable biomass available	1,605,170.28	tonne /year
Fuel Wood requirement	13,318,313.86	tonne /year
NRB	11,713,143.58	tonne /year
f_{NRB}	87.90%	

Following the Paragraph 10 of the applicable methodology, the f_{NRB} estimation is estimated as above and also two supporting indicators are established through the following –

- Survey results, national or local statistics, studies, maps or other sources of information, such as remote-sensing data, that show that carbon stocks are depleting in the project area.
- Increasing trends in fuel wood prices indicating a scarcity of fuel-wood

1. Depletion of Carbon Stock

According to the India State of Forest Report by Forest Survey of India, Ministry of Environment & Forests, Govt. of India there has been a conversion of the dense and moderately dense forest, to open forest due to felling, pruning or thinning of trees in the forest areas. An increase in the area of open forest is related to diversion of very dense and moderate dense forest to open forest. As per the Government of India Sustainable Forest Management Policy Land converted to open forest are taken up for plantation activity or promote natural or artificial regeneration. In this context it is also worthwhile to note that, the department of forest is undertaking initiatives towards plantation activity.

The table below represent the area under different forest cover:

All area in km ²				
Year	Very Dense	Moderately Dense	Open Forest	Total
2011	8,736	20,815	21,095	50,646
2009	8,739	20,834	21,077	50,650
2005	8,747	20,847	21,067	50,661

In accordance to the **Population Pressure and Deforestation in India- Population Research Centre, Institute of Economic Growth – Delhi**; the forest's growing stock reflects the quality of forest cover in terms of crown densities. The study exhibits the depletion in the forest stock in 1997 over 1989. Considering the dense forest growing stock is 67.6cubic metre/hectare and open forest growing stock as 28.5cubic metre/hectare; the volume of the growing stock in 1989 is estimated to be 227,592,000 cubic metres which is lowered to 223,516,000 cubic metres in 1997. The reduction in the volume of growing stock is estimated at 2% from 1997 in compared to 1989.

State	Volume of growing stock in 1989 (cubic metres)	Volume of growing stock in 1997 (cubic metres)	Percentage change in volume of growing stock
Maharashtra	227,592,000	223,516,000	-2%

2. Increase in fuel wood price trend

As per the consumer expenditure survey carried out by National Sample Survey Organisation in 2004; it has been portrayed that 54% of the total consumption expenditure for cooking and lighting in rural areas pertains to fuel wood consumption. The expenditure across the year is presented as follows:

Year	1997	1998	1999-2000	2000-2001	2002	2003	2005-2006	2006-2007
Average Monthly Per Capita Expenditure (Rs.)	27.97	31.79	36.45	44.14	51.70	56.20	68.77	76.20

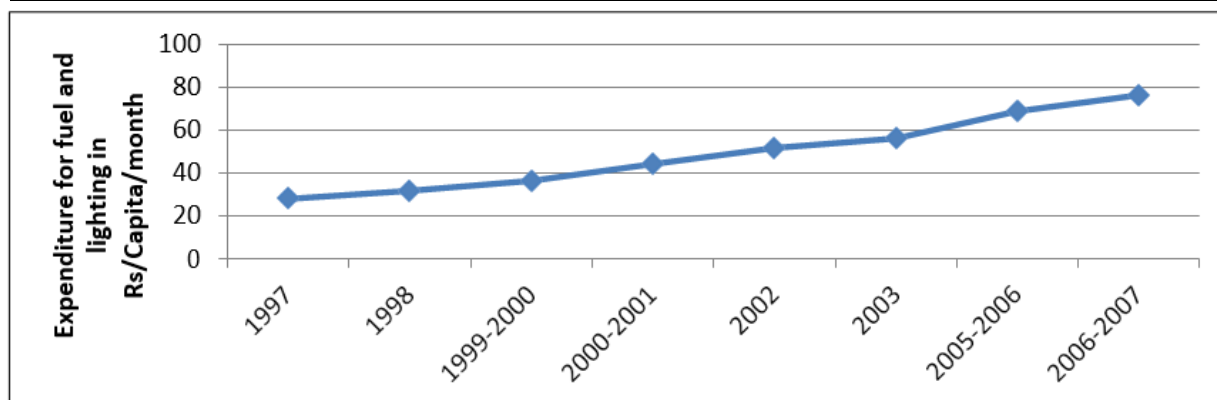

Since expenditure on fuel wood comprises of 43% of the total expenditure on fuel and lighting (considering 2004-05 data) it can be assumed that the cost of fire wood will increase in line with the increase in expenditure on fuel and light. Moreover the fact is also established from the mean annual increase in the price of the different energy products use for cooking and lighting and is as follows:

The trend in depletion of the carbon stock and rise of the fuel wood price is mainly due to increased demand and supply gap and unsustainable extraction or felling thereof. With the increase in demand of fire wood owing to population pressure and –limited and decreased potential for supply gap of fuel wood due depletion of carbon stocks (forest cover) the price is increasing. As the total biomass availability is unable to cater the demand of unsustainable extraction and pilferage is on the way towards depletion of the forest cover. The depletion of the carbon stock is due to the unsustainable extraction of biomass from the forest land and not due to any national policy. The national policy is aimed towards increasing of the forest area as the total area of forest at present is lower than the projected and required forest area as stipulated by the Govt. of India. Therefore, depletion of carbon stock or rise of the fuel wood price is not due to any national and Sectoral regulations but due to the stiffening of the gap between the demand and supply of fire wood in the region.

Please refer to section B 4 of PDD of the UNFCCC registered CDM project with Ref No. 8654 through the web link

Web-link: <https://cdm.unfccc.int/Projects/DB/RWTUV1355145232.18/view>

1.14 Compliance with Laws, Statutes and Other Regulatory Frameworks

The Project has received all the necessary approvals for development and commissioning for the proposed project from the respective State Nodal Agencies and is in compliance to the local laws and regulations.

There has been no policy regulation or legal enforcement that promotes deforestation of forest degradation in host country as well as in the region. National forest policy 1988, Government of India, Ministry of Environment and Forest, points out the requirement of forest conservation in the light of forest depletion in the country. Revenue and Forest Department, Government of Maharashtra vide circular no. FLD/1000/CR 243/F-3 16-December-2004, paragraph 3 has directed to prevent further deforestation in line with section 2 of the Forest Conservation Act 1980. The National mission for Green India, one of the eight Missions on National Action plan on Climate Change has also pointed out use of efficient biomass stoves as a measure towards preventing forest degradation.

The trend in depletion of the carbon stock and rise of the fuel wood price is mainly due to increased demand and supply gap and unsustainable extraction or felling thereof. With the increase in demand of fire wood owing to population pressure and –limited and decreased potential for supply gap of fuel wood due depletion of carbon stocks (forest cover) the price

is increasing. As the total biomass availability is unable to cater the demand of unsustainable extraction and pilferage is on the way towards depletion of the forest cover. The depletion of the carbon stock is due to the unsustainable extraction of biomass from the forest land and not due to any national policy. The national policy is aimed towards increasing of the forest area as the total area of forest at present is lower than the projected and required forest area as stipulated by the Govt. of India. Therefore, depletion of carbon stock or rise of the fuel wood price is not due to any national and Sectoral regulations but due to the stiffening of the gap between the demand and supply of fire wood in the region.

The design of the cook stove is certified by Bureau of Indian Standards relating to its appropriateness to, IS 13152 (Part1). The standard was adopted by Bureau of Indian Standard after the draft finalized by the oil burning Appliances Sectional Committee had been approved by Heavy Mechanical Engineering Division Council.

1.15 Participation under Other GHG Programs

1.15.1 Projects Registered (or seeking registration) under Other GHG Program(s)

Project has been registration with UNFCCC under Clean Development Mechanism program, Registration reference number is 8654.

1.15.2 Projects Rejected by Other GHG Programs

The Project is not rejected by any other GHG programs.

1.16 Other Forms of Credit

1.16.1 Emissions Trading Programs and Other Binding Limits

India is Non-annex1 country and there is no compliance with an emission trading program or to meet binding limits on GHG emissions for this project activity. The project is registered under CDM with registration ID 8654. Project Proponent has submitted undertaking that they will not claim same GHG emission reductions of the project from CDM and VCS. PP would not use net GHG emission reductions by the projects for compliance with emission trading program to meet binding limits on GHG emissions. PP has also submitted an undertaking stating that they will not take REC benefits for the same Emission Reductions.

1.16.2 Other Forms of Environmental Credit

Project has been registered with UNFCCC under Clean Development Mechanism program. Registration reference number is 8654. Project Proponent has submitted undertaking for not availing other forms of environmental credit for the same crediting period under

consideration. Project Participant is not taking REC benefits for the same emission reductions

1.17 Additional Information Relevant to the Project

Leakage Management

Not applicable to this project activity.

Commercially Sensitive Information

No commercially sensitive information has been excluded from the public version of the project description.

Sustainable Development

The project contribution towards sustainable development is established in line with the sustainable development indicator framed by the host country DNA:

Social benefits:

- Reduces drudgery of women and children of rural areas (due to reduced fuel wood use) by reducing time spent and distance travelled for fuel wood collection. Reduction in firewood requirement would help in spending more time in productive activities such as education, employment etc.
- Improves overall health (particularly diseases related to respiratory system) of women and children by reducing smoke in the kitchen.

Environmental benefits:

- Improves the local environment by reducing rate of forest degradation /deforestation in the project area. Conservation of forest will not only reduce non-renewable biomass demand and also reduce soil erosion and loss of biodiversity as a consequence of deforestation.
- Reduces emission of black carbon to the atmosphere.
- Reduces Green-house gas emissions.

Economic benefits:

- Employment opportunities for local communities involved in monitoring, training of users, undertaking periodic maintenance and post life time replacement.

- Reduces the expenditure involved in the pre project scenario for purchase of fuel wood.

Technological benefits:

- Introduction of new technology to the rural communities.
- Knowledge transfer to trainers including technicians for pertaining training to users, maintenance of system.
- Demonstration of a successful project at household level will create replication potential in other states and countries.

In view of the above, the project proponent considers that, the project activity profoundly contribute towards sustainable development of the region as well as of the nation.

Further Information

There are no information or incidents that will have bearing on the eligibility of the project, the net GHG emission reductions or removals, or the quantification of the project's net GHG emission reductions or removals.

2 SAFEGUARDS

2.1 No Net Harm

According to the Ministry of Environment and Forests (MoEF), Government of India, under the Environment Impact Assessment Notification vide S .O.1533(E), dated 14/09/2006; the project activity of utilization of Improved Cook stove for cooking in rural households does not require environmental impact assessment study to be carried out.

2.2 Local Stakeholder Consultation

Please refer to sections E 1 and E 2 of PDD of the UNFCCC registered CDM project with reference no. 8654.

The web link of the same is given below:

<https://cdm.unfccc.int/Projects/DB/RWTUV1355145232.18/view>

2.3 Environmental Impact

Please refer to sections D 1 of PDD of the UNFCCC registered CDM project with reference no. 8654.

The web link of the same is given below:

<https://cdm.unfccc.int/Projects/DB/RWTUV1355145232.18/view>

2.4 Public Comments

The project Description has been web-hosted. Public comments will be incorporated once the commenting period is over.

2.5 AFOLU-Specific Safeguards

Not Applicable

3 APPLICATION OF METHODOLOGY

3.1 Title and Reference of Methodology

Consolidated baseline methodology for “Energy efficiency measures in thermal applications of non-renewable biomass”; AMS II-G, Version 03.0.0 Sectoral Scope: 03, EB 60.

3.2 Applicability of Methodology

The project activity involves replacement of the traditional cook stoves by improved cook stoves. The improved cook stoves owing to its higher combustion efficiency of 29.88% in comparison to 10%¹² efficiency of the traditional cook stoves results in efficiency improvement and same do not exceed equivalent of 20 Giga watt hour (GWh) (60 giga watt hour thermal (GWhth))per year. The project is selected for applying small scale methodologies under Type II. As the cumulative energy saving from the project activity is less than 20 GWh/annum or 60 GWhth/annum and each of the independent sub-systems i.e. Improved cook stoves used in household only for the purpose of cooking results an estimated annual energy savings of 4.073 MWhth or 1.358 MWh (detailed calculation

¹² Traditional cookstove is being used among all households in the baseline as per the survey, thus thermal efficiency is considered 10% for traditional stove according to the methodology.

presented in section B.5. of the PDD) which is well smaller than permissible limit of 600 MWh. Therefore, the project is considered appropriate to be developed under micro small scale guidelines. The applicability criteria of the chosen methodology AMS-II. G (Version 03) is satisfied by the project activity in following manner:

Criteria 1

This category comprises appliances involving the efficiency improvements in the thermal applications of non-renewable biomass. Examples of these technologies and measures include the introduction of high efficiency biomass fired cook stoves or ovens or dryers and/or improvement of energy efficiency of existing biomass fired cook stoves or ovens or dryers.

Justification: The project activity involves dissemination of higher efficiency biomass fired cook stoves use as household appliances (29.88% as tested from MNRE approved centre) for cooking purpose. This will contribute in reduction of non-renewable biomass consumption which would have been otherwise consumed by less efficient cook stoves. Since, it is an introduction of high efficiency cook stove the above condition is justified.

Criteria 2:

Project participants are able to show that non-renewable biomass has been used since 31 December 1989, using survey methods or referring to published literature, official reports or statistics.

Justification: Use of non-renewable biomass is established through demonstration of gap between the demand of fire wood and silviculturally permissible production of biomass from forest and tree outside forest. The fact is established using published literature referring to the following studies:

Food and Agricultural Organisation of United Nation - Regional Wood Energy Development Programme in Asia

The literature highlights gap in demand and supply of fuel wood across the country as well as across the state of Maharashtra. In accordance to the study, fuel wood consumption in real terms is much higher than the recorded production of about 30%; thus, leaving a wide gap leading towards unsustainable extraction of fire wood. Moreover, on account of population pressure, demand for firewood has outstripped natural regeneration and planting, so much so that in some areas there is food to eat but not enough wood is available to cook it (Mathur, 1987)". The report also highlight the statistics from Forest Survey of India (FSI1988:46) which estimated a gap of 130 million tonne between the demand and internal production of firewood in the country in 1987. The study also highlight demand for fuel-wood

across Maharashtra in 1980 around 17 million cu.m.as against the production of 1.5 million cu. m. from the recorded forest (Pethiya & Luthra, 1991). The quoted demand supply gap of fire wood is also highlighted in the finding of the National Council for Applied Economic Research (NCAER).

State of Forest Report 1987, MoEF, Govt. of India

The report highlights gap between the demand and production of fire wood as major cause of deforestation. The reported consumption and production across the country within silvi culturally permissible limit across the following years is indicated as follows –

Year	Consumption in million tones	Recorded Production in million tonnes
1953-54	86.3	6.49
1960-61	99.6	8.15
1965-66	109.3	9.16
1970-71	117.9	11.62
1975-76	133.1	19 m. from forest and 30 m. from tree outside forest

In accordance the gap between demand and production is met through pilferage leading to continuous depletion of forest land.

Wood Fuel Trade in India: Food and Agricultural Organisation of United Nation

The report outlines demand- supply gap which has referred the expert committee report of MoEF dated 30.01.1998 as below –

In million cubic metre			
Year	Consumption	Sustainable Production	Gap
1953-54	115.0	8.8	106.2
1965-66	163.9	13.7	150.2
1975-76	199.6	28.5	171.4
1987-88	235.0	40.0	195.0

Rural energy data sources and estimations in India - TERI

The report refers to gap between consumption and recorded production of fuel-wood has however increasing, indicating seriousness of the fuel-wood scarcity in India.

Fuel wood consumption and sustainable production since 1947

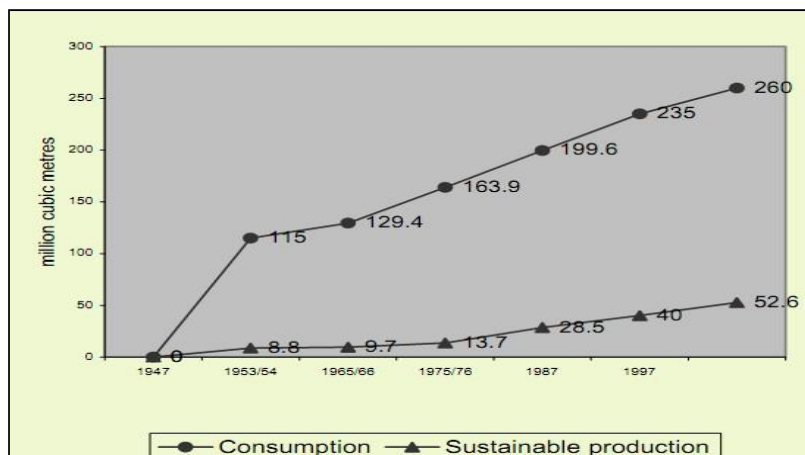

Conclusion:

Therefore, it is established from the above studies that, a staggering gap exists between the demand and potential for sustainably extractable fuel wood from forest land. While the first three studies refer to the fuel wood supply scenario and the gap that were precedent before 1989; the study by TERI highlight the widening of gap between the demand and supply of biomass after 1989. The widening of the gap has been both due to the increased population pressure as well as the conversion of dense forest to medium dense, scrub and open type forest land due to unsustainable extraction even after the government's initiative towards promotion of afforestation. Thus, it can therefore be concluded that the gap exists from and before 1989 and continued thereafter, forcing the population in using biomass extracted in un- sustainable manner which is identified as non-renewable component.

As demonstrated above, the project activity satisfies qualifying criteria of the selected methodology AMS - II.G. Hence, the choice of the methodology is justified.

3.3 Project Boundary

According to the Paragraph 3 of approved methodology AMS-II.G., "The project boundary is the physical, geographical site of the efficient systems using biomass".

The project boundary is therefore, encompasses physical, geographical sites of all 14,600 individual households possessing efficient cook stove in the district of Ahmednagar and Nandurbar of Nashik Division, Maharashtra. Based on the methodology, GHG included for the baseline and project scenario, leakage for the project activity is CO₂.

Source	Gas	Included?	Justification/Explanation
Baseline Emission	CO ₂	Yes	This is the major Green-house gas

Source	Gas	Included?	Justification/Explanation
combustion fuel wood traditional stove from of in cook			emitting from combustion of fuel wood in the baseline scenario.
	CH ₄	No	Not Applicable as per the applicable methodology
	N ₂ O	No	Not Applicable as per the applicable methodology
Project Emission from consumption of fuel wood in efficient cook stoves	CO ₂	No	Not Applicable as per the applicable methodology
	CH ₄	No	Not Applicable as per the applicable methodology
	N ₂ O	No	Not Applicable as per the applicable methodology
Leakage Emissions	CO ₂	Yes	Baseline fuel wood consumption is multiplied by a net to gross adjustment factor of 0.95 to account for leakages.
	CH ₄	No	Not Applicable as per the applicable methodology
	N ₂ O	No	Not Applicable as per the applicable methodology
	CO ₂	No	Not Applicable as per the applicable methodology
	CH ₄	No	Not Applicable as per the applicable methodology
	N ₂ O	No	Not Applicable as per the applicable methodology

3.4 Baseline Scenario

Please refer to section B 4 of PDD of the UNFCCC registered CDM project reference no. 8654.

The web link of the same is given below:

<https://cdm.unfccc.int/Projects/DB/RWTUV1355145232.18/view>

3.5 Additionality

Please refer to section B 5 of PDD of the UNFCCC registered CDM project reference no. 8654.

The web link of the same is given below:

<https://cdm.unfccc.int/Projects/DB/RWTUV1355145232.18/view>

3.6 Methodology Deviations

Not Applicable, as there are no methodological deviations for this project activity.

4 QUANTIFICATION OF GHG EMISSION REDUCTIONS AND REMOVALS

4.1 Baseline Emissions

Please refer to section B 6.1 of PDD of the UNFCCC registered CDM project reference no. 8654.

The web link of the same is given below:

<https://cdm.unfccc.int/Projects/DB/RWTUV1355145232.18/view>

4.2 Project Emissions

Please refer to section B 6.1 of PDD of the UNFCCC registered CDM project reference no. 8654.

The web link of the same is given below:

<https://cdm.unfccc.int/Projects/DB/RWTUV1355145232.18/view>

4.3 Leakage

Please refer to section B 6.1 of PDD of the UNFCCC registered CDM project reference no. 8654.

The web link of the same is given below:

<https://cdm.unfccc.int/Projects/DB/RWTUV1355145232.18/view>

4.4 Net GHG Emission Reductions and Removals

Please refer to section B 6.4 of PDD of the UNFCCC registered CDM project reference no. 8654.

The web link of the same is given below:

<https://cdm.unfccc.int/Projects/DB/RWTUV1355145232.18/view>

Year	Estimated baseline emissions or removals (tCO ₂ e)	Estimated project emissions or removals (tCO ₂ e)	Estimated leakage emissions (tCO ₂ e)	Estimated net GHG emission reductions or removals (tCO ₂ e)
20-November-2012 to 19-November-2013	13,816	0	691	13,125
20-November-2013 to 19-November-2014	13,816	0	691	13,125
20-November-2014 to 19-November-2015	13,816	0	691	13,125
20-November-2015 to 19-November-2016	13,816	0	691	13,125
20-November-2016 to 19-November-2017	13,816	0	691	13,125
20-November-2017 to 19-November-2018	13,816	0	691	13,125
20-November-2018 to 19-November-2019	13,816	0	691	13,125

20- November- 2019 to 19- November- 2020	13,816	0	691	13,125
20- November- 2020 to 19- November- 2021	13,816	0	691	13,125
20- November- 2021 to 19- November- 2022	13,816	0	691	13,125
Total	138,160	0	6910	131,250

5 MONITORING

5.1 Data and Parameters Available at Validation

Please refer to section B 6.2 of PDD of the UNFCCC registered CDM project reference no. 8654.

The web link of the same is given below:

<https://cdm.unfccc.int/Projects/DB/RWTUV1355145232.18/view>

5.2 Data and Parameters Monitored

Please refer to section B 7.1 of PDD of the UNFCCC registered CDM project reference no. 8654.

The web link of the same is given below:

<https://cdm.unfccc.int/Projects/DB/RWTUV1355145232.18/view>

5.3 Monitoring Plan

Please refer to section B 7.2 of PDD of the UNFCCC registered CDM project reference no. 8654.

The web link of the same is given below:

<https://cdm.unfccc.int/Projects/DB/RWTUV1355145232.18/view>